



Professional Roofing System Manufacturer
Hangzhou Singer Building Materials Co., Ltd

--stone coated metal roof tile

--Asphalt shingle

--PVC rain gutter

Since 2006



CONTENTS

- 1: About PVC Rain Gutters.
- 2: Specifications.
- 3: Project Show and Advantages
- 4: Packages.
- 5: Shipment.
- 6: Factory Show.
- 7: Installment.
- 8: Quality Show
- 9: FAQ
- 10: Contacts



1: ABOUT PVC GUTTER

PVC gutters, also called vinyl gutters, are an interesting alternative to traditional guttering systems like cooper, seamless and aluminum system. They collect the water that runs off the roof, protecting the home's siding, basement and foundation from water damage. It originated in Scandinavia where temperatures run wild, from forty below in the winter to sixty above in the summer. So PVC gutters definitely have a big upside: like any plastic product, they can withstand extreme weather conditions. Of course, this strength is important when it comes to any exterior installation, especially guttering which has to endure some serious rain and snowmelt.

HOW IT WORKS

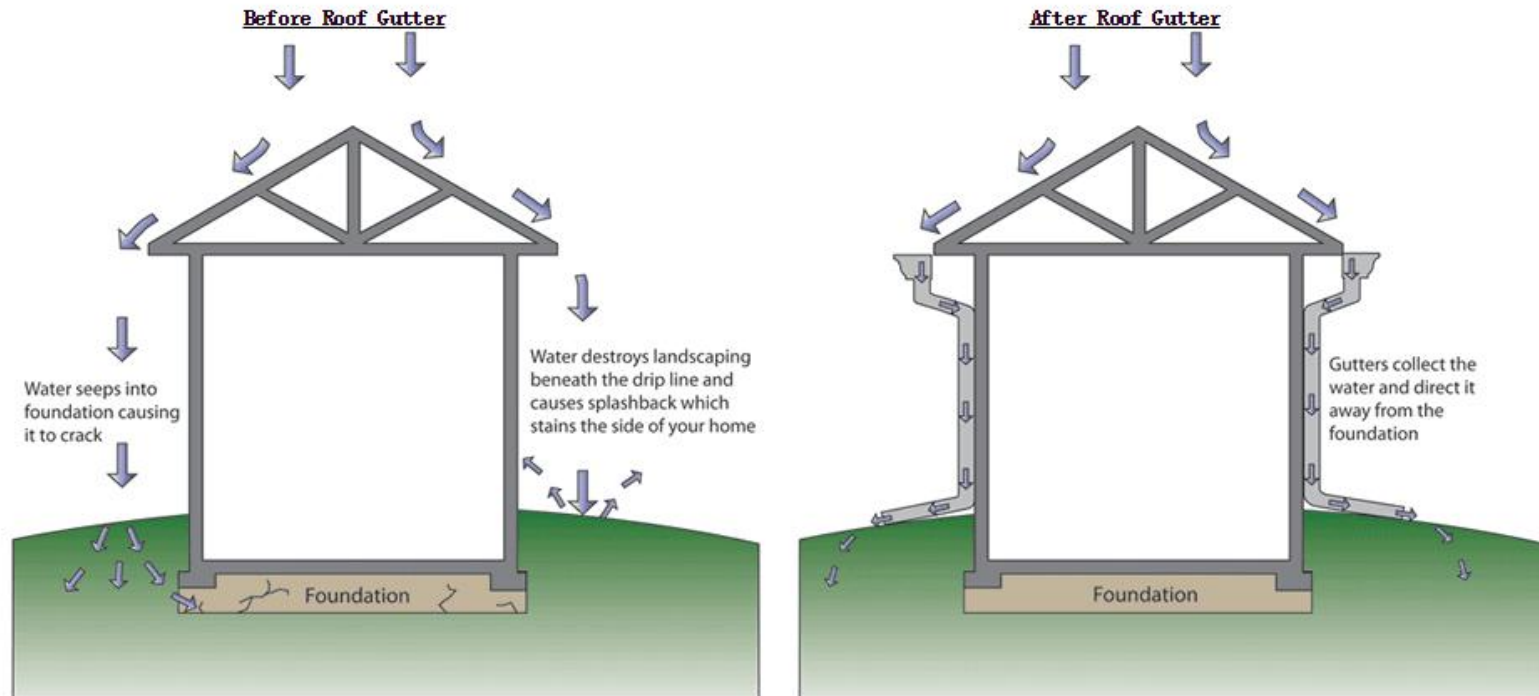

SPECIFICATION - PVC GUTTER

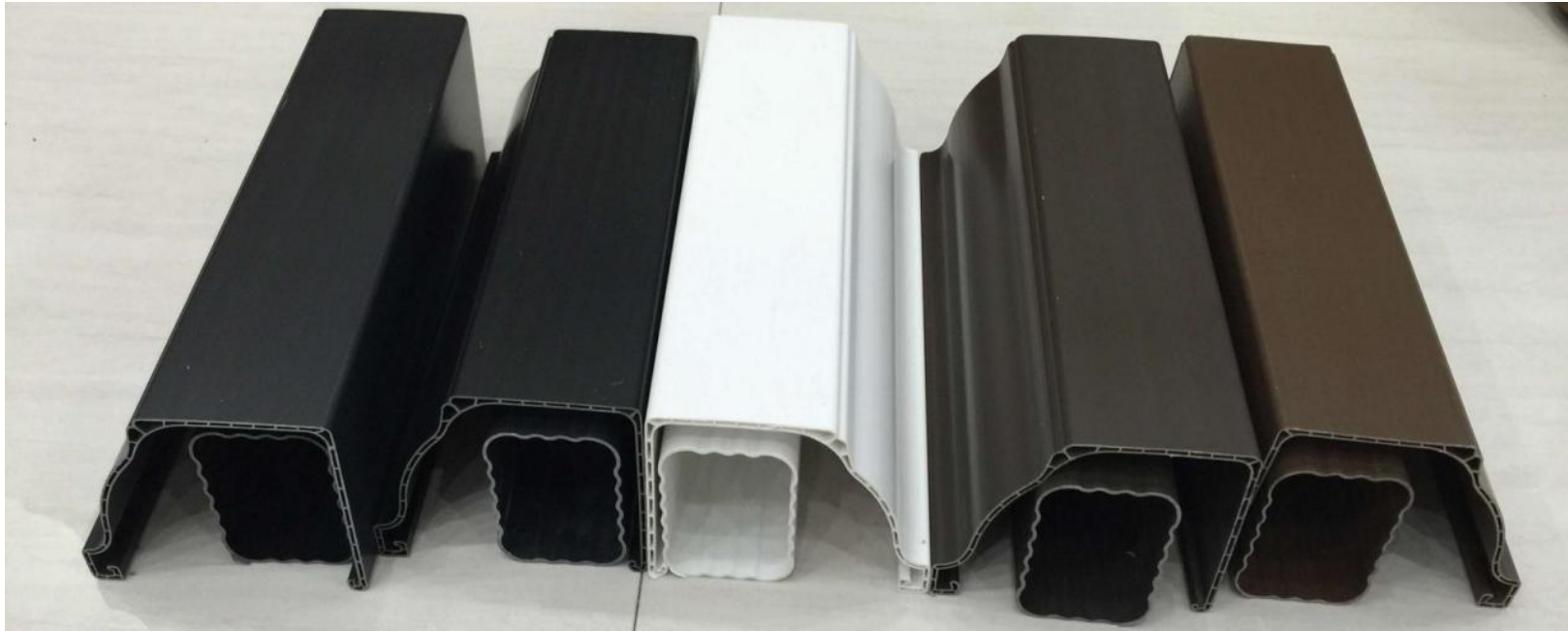

Materials	Specification	Gutter				Downspout	
		Upper (mm)	Down (mm)	Depth (mm)	Thickness (mm)	Length and Width (mm)	Thickness (mm)
PVC	5.2 Inch	130	85	105	3.4	86×63	1.9
	7Inch	145	130	108	1.9	80×100	1.9



Rain Gutter and Accessories



Rain Gutter



Hanger A



End Cap



Gutter Joiner



135° Inside Corner



135° Outside Corner



90° Outside Corner



90° Inside Corner



Drop Outlet



Hanger B

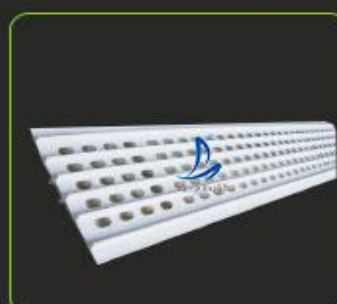

Leaf Guard

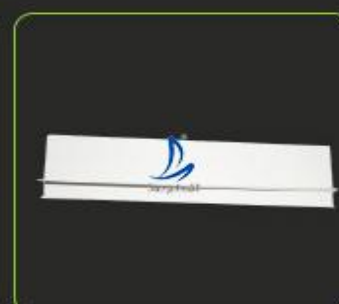

Flashing



Downspout and Accessories

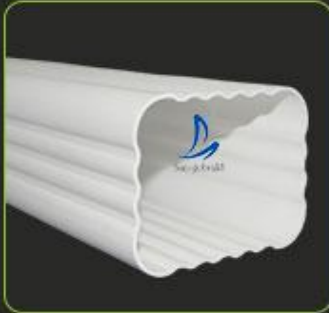

Downspout



Connector



Arc. Drop Outlet



Downspout Clip



90° Elbow

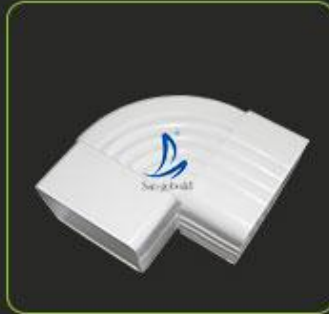

90° Diverter



65° Elbow



65° Diverter



Equal Tee

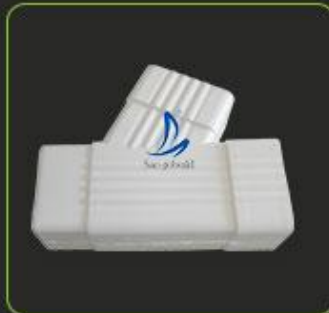

Skew Tee



Conversion Joint $\Phi 75$



Conversion Joint $\Phi 110$



SPECIFICATIONS - PVC GUTTER AND ACCESSORIES

- 1: 70% New PVC contents for durable quality warranty.
- 2: Largest stock in China.
- 3: New ASA gutter which would never fade.

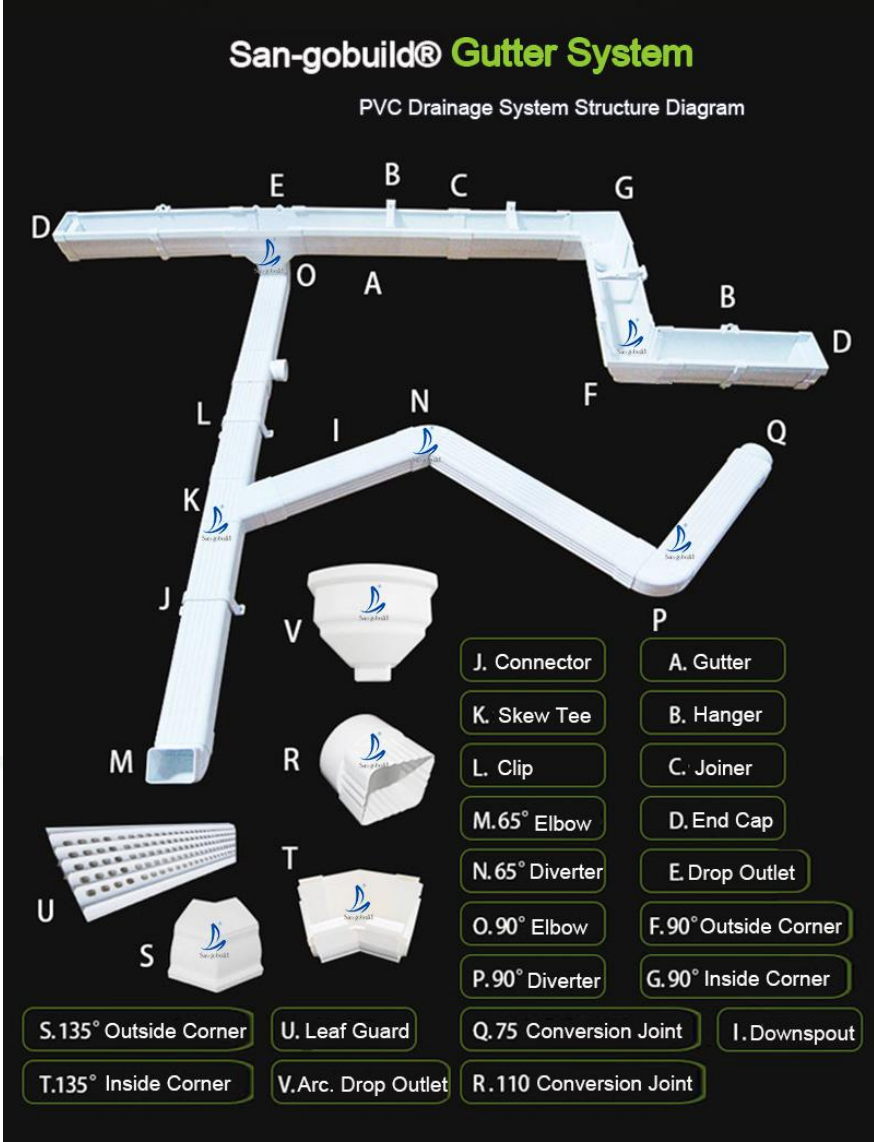
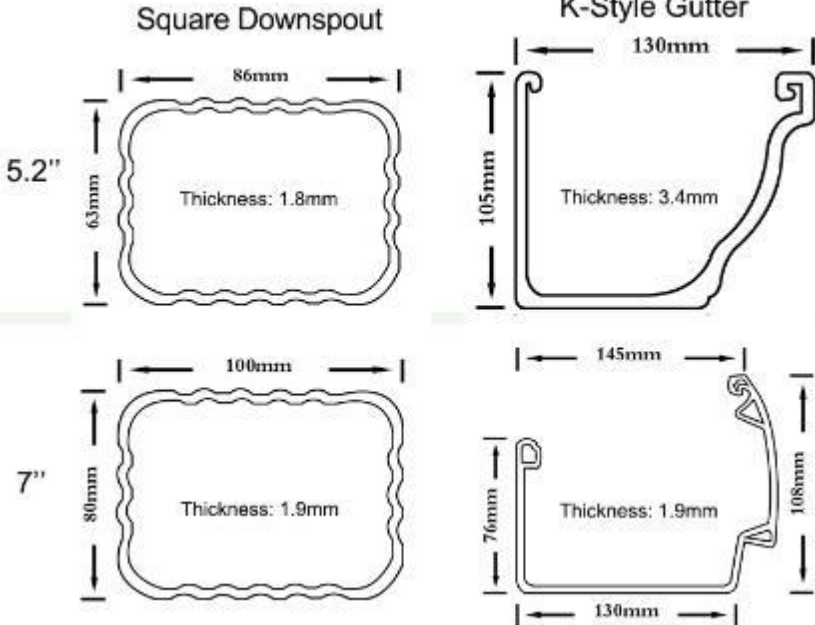

ADVANTAGES - PVC GUTTER

Strength

PVC is made from molded plastic which means that the gutters are formed in one continuous unit. There is no paint to scratch or welded seams to corrode over time. In the shape and size of gutters, plastic is stronger than the metal alternatives. The weight of snow, ice or other loads will have less of an effect on PVC gutters. Plus, ladders will not dent the material and any blemishes on the surface will not be visible.

Flexibility

Another reason to use PVC is its flexibility. Unlike metal gutters, PVC will not lose its shape when it bows slightly. In fact, it is manufactured to be able to bow with weight. Metal gutters are flexible, but when their shape is distorted they stay that way. Bending, denting and twisting effects in metal gutters are easily visible and can become an eyesore. With PVC, you avoid these problems.

Price

Using PVC for your gutters is less expensive than installing metal. You do not want the final result to look cheap, but if you pick the right product, you will end up with a nice system of gutters at an affordable price. Be sure to hire the right people to install it so that

Adaptability

Because PVC gutters are injection molded plastic, their shape and color can be adapted to the style of your home. Custom orders will likely increase the price you pay, but if you want the gutters to match precisely with the exterior of your home, this is an option available to you. You may also be able to purchase PVC gutters made from recycled materials. In this way, you are contributing to a sustainable living arrangement while using a superior product.

Installation

PVC gutters are easy to install. The sections of PVC are very lightweight and snap together quickly. With the right tools, it is a job that you can do yourself without a lot of expense. There is a skill to the installation of gutters including the proper mounting and pitch, but because PVC is less burdensome to work with, the job is easier.



ADVANTAGES - PVC GUTTER

Durability

PVC is very light, flexible and strong. It is well suited for use in colder temperatures that receive a lot of snowfall. Also, because it is water-resistant, PVC gutters will never freeze, rust or corrode.

Because the material is more durable, especially in regions prone to extreme weather, PVC is superior to metal gutters. It is less expensive than metal, yet it is customizable to adapt to the exterior finish of your home. If you are replacing your gutters, consider PVC as a viable option.



ADVANTAGES - PVC GUTTER



✔ The other factory waste



✔ The raw materials for san-gobuild



✔ Ordinary downspouts before testing



✔ San-gobuild downspouts before testing



✔ The ordinary downpipe test



✔ San-gobuild for testing



✔ After the test of ordinary downpipe



✔ After the test of San-gobuild downpipe

7inch gutter and downspout mixed packages



5.2inch gutter and downspout mixed packages

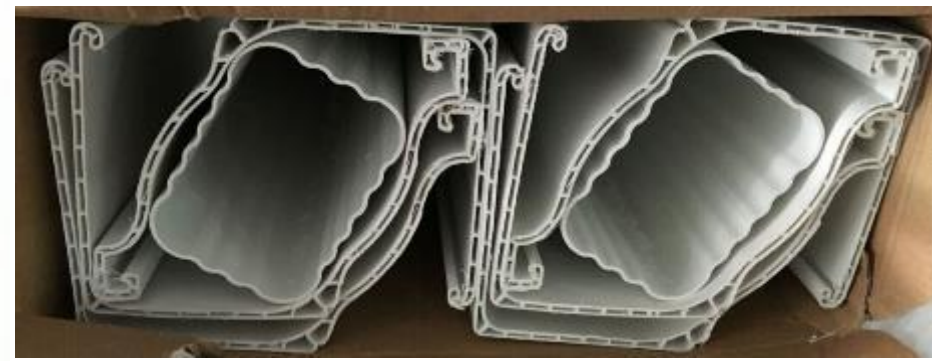

PACKAGES ADN SHIPMENT



FACTORY SHOW-PVC



SPECIFICATION OF ALUMINUM GUTTER SYSTEM

● Colored Aluminum Drainage System Structure

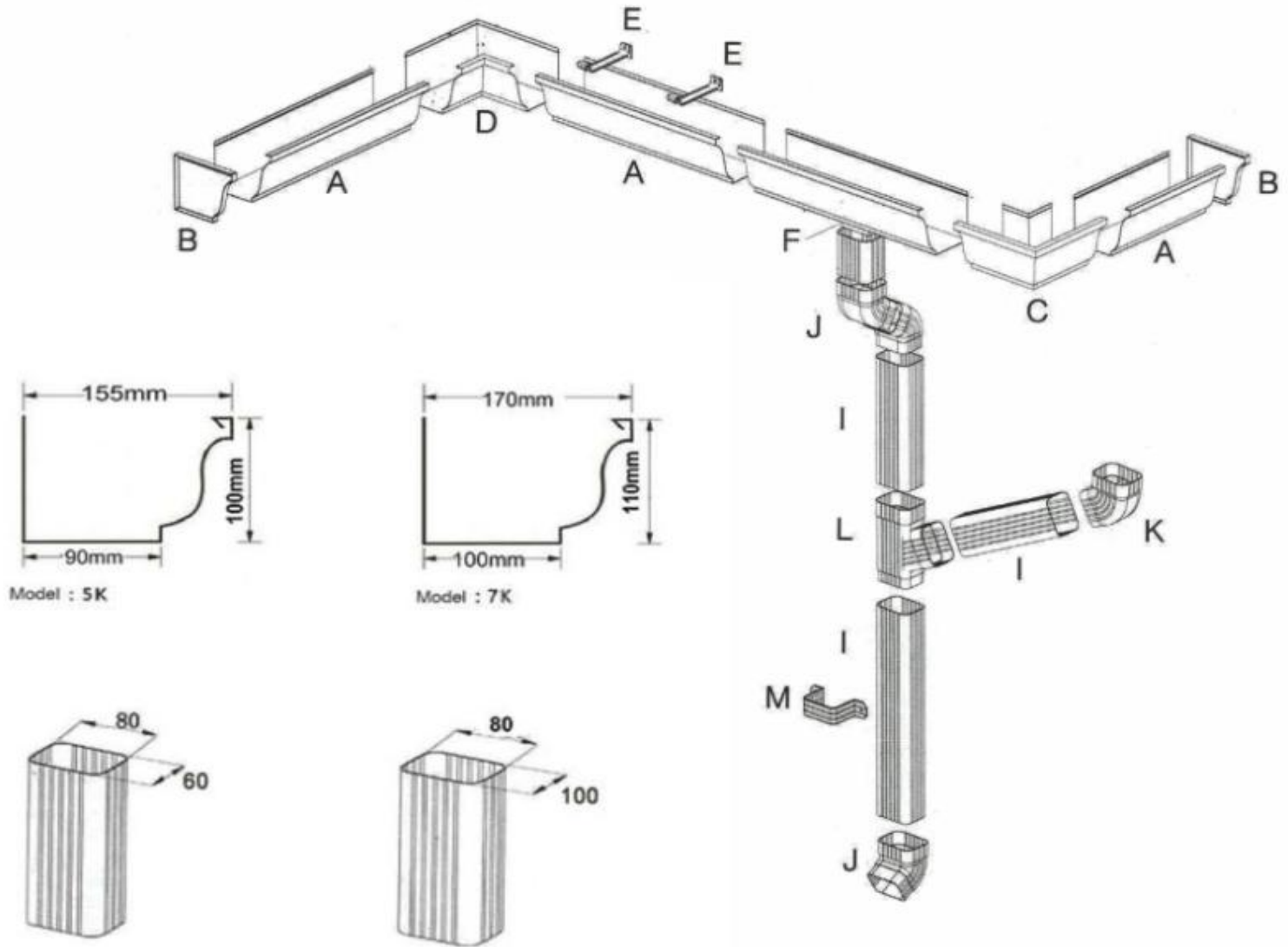

SPECIFICATION OF ALUMINUM GUTTER SYSTEM

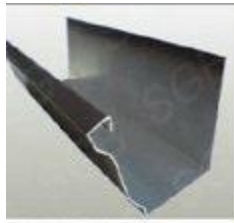

SJ-01 Rain Gutter



SJ-02 End Cap

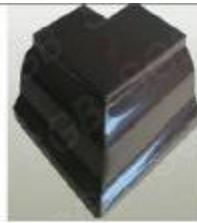

SJ-03 90° Outside Corner



SJ-10 65° Downspout Elbow

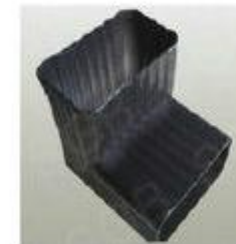

SJ-10 90° Downspout Elbow

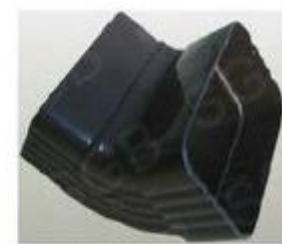

SJ-11 65° Downspout Diverter A



SJ-09 Downspout



SJ-06 Drop Outlet A



SJ-05 Gutter Hanger

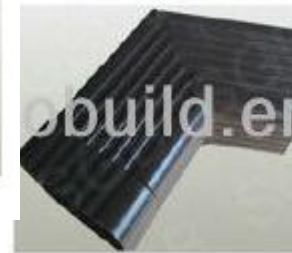

SJ-11 135° Downspout Diverter C



SJ-12 135° Ske Tee



SJ-13 Downspout Clip A



SJ-14 Downspout Connector



SJ-11 90° Downspout Diverter B



SJ-06 Drop Outlet B



SJ-13 Downspout Clip B



SJ-15 Arc. Drop Outlet

Materials	Specification	Gutter				Downspout		Water Discharge	
		Upper (mm)	Down (mm)	Depth (mm)	Wall Thickness (mm)	Length and Width (mm)	Wall Thickness (mm)	Traditional Shingle	Fiberglass Asphalt Shingle
Aluminum Alloy	5"	145	85	90	1.0	50x60	1.0	30-50m ²	50-80m ²
	6"	155	100	110	1.0	60x80	1.0	50-100m ²	50-100m ²
	7"	185	120	115	1.0	60x80	1.0	120m ²	120m ²



FACTORY SHOW OF ALUMINUM GUTTER SYSTEM



SET OF SAMPLES



PVC GUTTER

ALUMINUM GUTTER



LUXURY YOUR HOUSE



WHY K-STYLE GUTTERS?

K-style PVC VS Metal rain gutter



- PVC rain gutter more **ECONOMIC** than metal rain gutter
- PVC rain gutter **LIGHTER** than metal rain gutter
- PVC rain gutter **EASIER** install
- PVC rain gutter **SEAMLESS** better



Packages For Less Than Full Container



K-style VS U Shape rain gutter



- K-style carry **TWICE** more water in the same size
- Rectangle gutter & pipe fix more **SECURE** than round gutter & pipe
- K-style **EASIER** install
- **DURAL** gutter wall design , double protect

FAQ

1: Which size of gutter I should choose?

The size and style of gutters you choose is influenced by the location of your house and the environment surrounding it. In the common, 5.2 inch gutter is enough, we suggest you could consider using 7inch if your house has the factor of below,

1): Large house with big roofing area.

2): Houses found in heavy rain areas. Like tropical rainy climate area.

3): Roofing tile made of hard materials (such as tile and slate) and on steeply sloped roofs, in order to prevent the rainwater from overshooting the gutter.

2: Delivery time

Within 7days.

3: Packages.

PE and BOX standard packages. OEM service offered.

4: Warranty.

Never fading and 15 years lifetime.



ABOUT SAN-GOBUILD

Hangzhou Singer Building Material Co.,Ltd was built in May, 2006.

15years passed, Sangobuild started from a small factory with only 10 employees to three factory with over 400 workers. Now, we have *stone coated roofing tile, asphalt shingle and pvc rain gutter production line* with advanced technology learned from USA and Korea. Four office you could visit us in anytime in Tianjin, Jinan, Hangzhou(Head office) in China.

Since 2017, our new production line setteled done in Tianjin city. The new products is for USA market with UL certificate. Sangobuild to be the first factory who has right to export stone coated roofing tile to USA!

Three things we heren promise to you:

1:"Quality is our culture", all of our technology is imported from New Zealand, South Korea and USA.

2:"With us your money is safe",full refund in case of bad quality or delay delivery time. Furthermore, we have USD220,000 as deposit in Alibaba.

3:"Professional service", we are doing it!

